



INSTRUCTIONS D'ASSEMBLAGE
ASSEMBLY INSTRUCTIONS

MONARCH
SPECIALTIES INC.

I 1043

TABLE A MANGER -
36"X 48" / GRIS CIMENTE / METAL CHROME

DINING TABLE -
36"X 48" / GREY CEMENT / CHROME METAL





**POUR DE L'ASSISTANCE OU POUR COMMANDER
DES PIÈCES CONTACTEZ NOTRE DÉPARTEMENT
DE SERVICE À LA CLIENTÈLE.**

**FOR ASSISTANCE OR TO ORDER PARTS
CONTACT OUR CUSTOMER SERVICE DEPARTMENT**

WWW.MONARCHSERVICE.COM

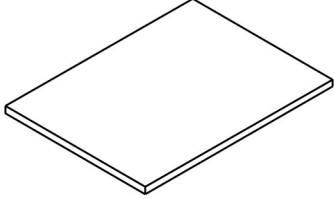
LISTE DES PIÈCES
PARTS LIST

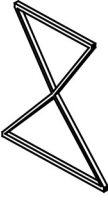
PIÈCE / PART #	IMAGE	DESCRIPTION	QTY / QTÉ
1		TABLE TOP SURFACE DE TABLE	1
2		LEG PATTE	2
3		SIDE FRAME CADRE DE CÔTÉ	2

LISTE DES PIÈCES DE MONTAGE
HARDWARE LIST

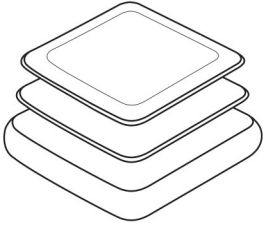
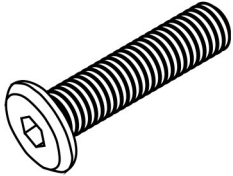
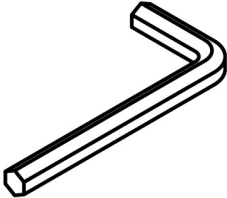
PIÈCE / PART #	IMAGE	DESCRIPTION	QTY / QTÉ
A		<p align="center">FLOOR PROTECTOR - 3/4" X 3/4"</p> <p align="center">PROTECTEUR DE PLANCHER - 3/4" X 3/4"</p>	4
B		<p align="center">ASSEMBLING BOLT - Ø1/4" X 1 1/2"</p> <p align="center">BOULON D'ASSEMBLAGE - Ø1/4" X 1 1/2"</p>	12
C		<p align="center">HEX KEY</p> <p align="center">CLÉ HEXAGONALE</p>	1



OUTIL DE VÉRIFICATION DE DIMENSIONS DES PIÈCES
HARDWARE DIMENSIONS VERIFICATION TOOL

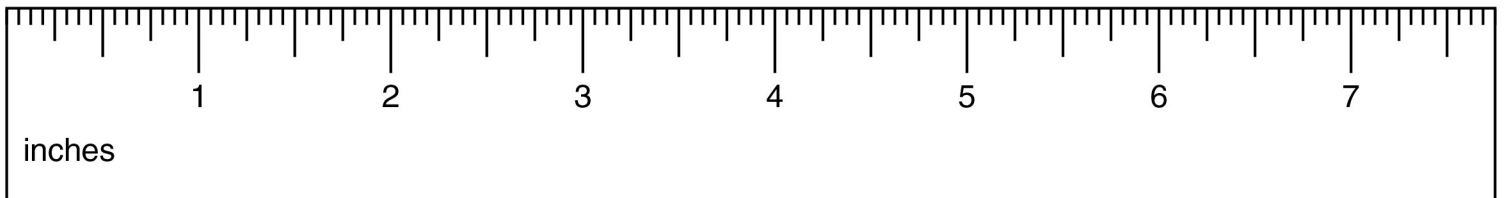

ÉTAPE / STEP 1

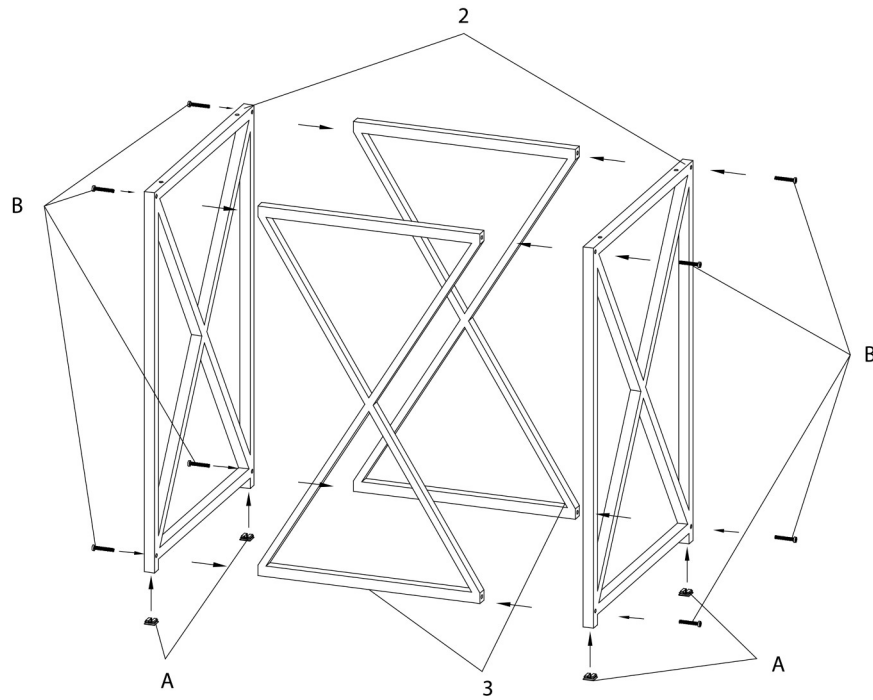

ÉTAPE / STEP 2

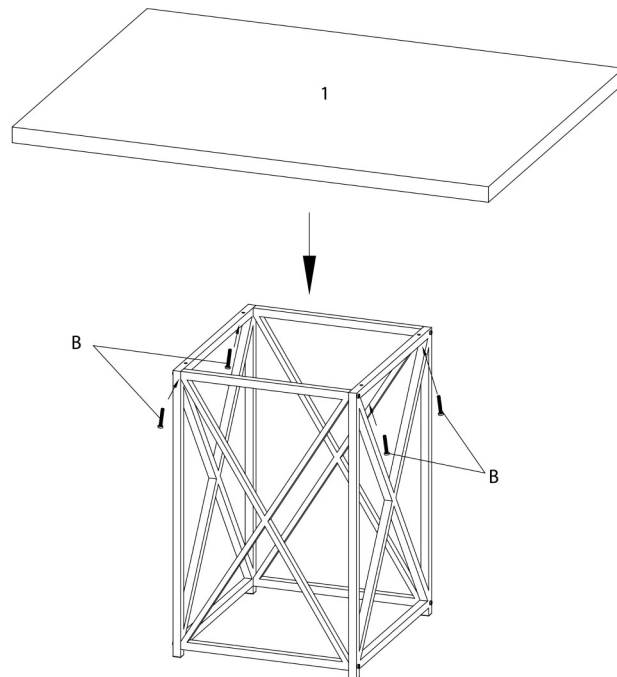

ÉTAPE / STEP 3

